

# X-FRAME TO TABLE CONNECTIONS

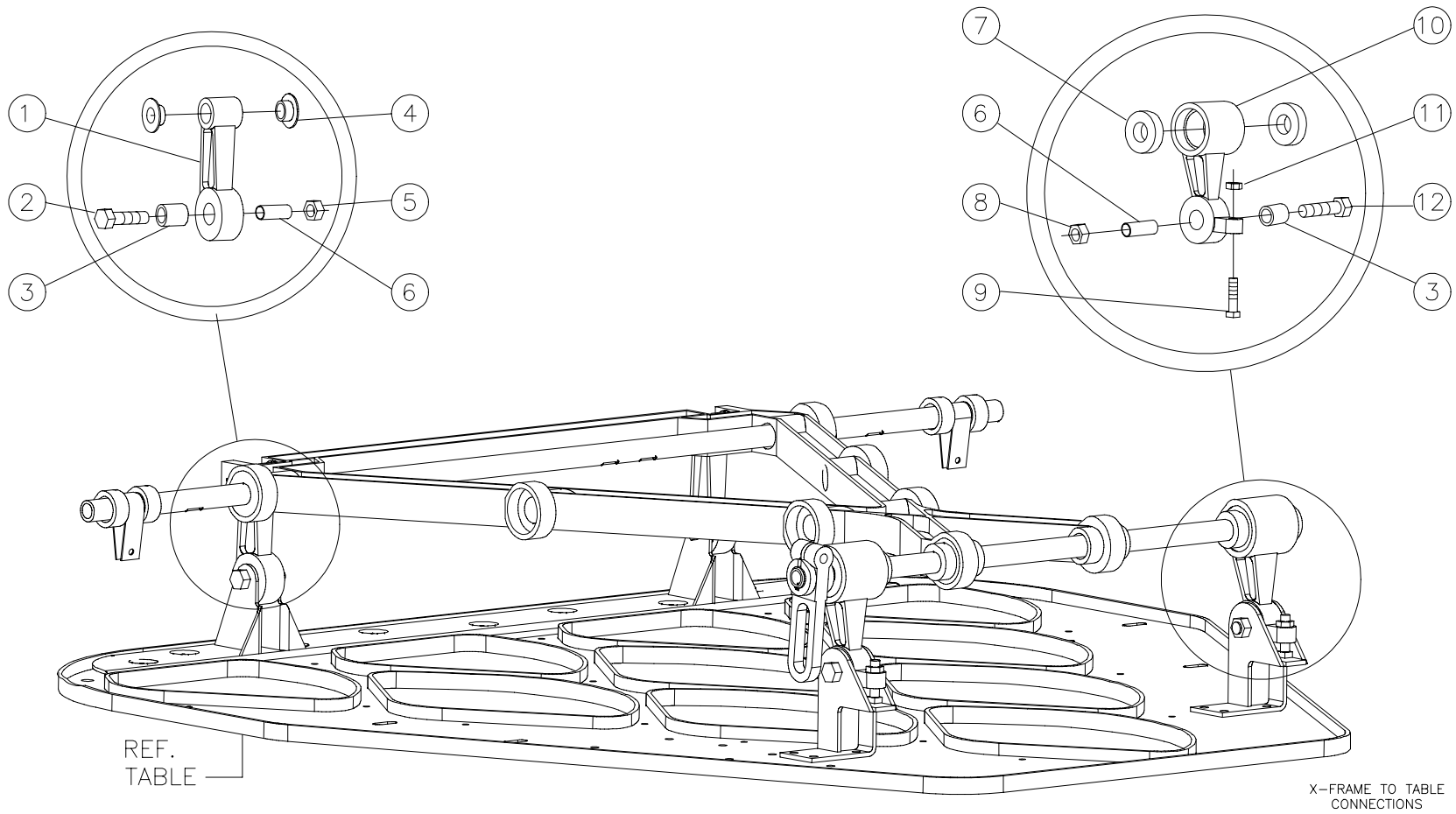



## X-FRAME TO TABLE CONNECTIONS

ITEM	QTY	PART #	DESCRIPTION
1	2	090-005-547	REAR LEG
2	2	809-865-325	SCREW, HEX, 3/8 - 16 X 2
3	4	090-005-593	AXLE TUBE (SLEEVE)
4	4	000-023-114	FLANGED BEARING, .628 X .815 X .06
5	2	844-065-002	NUT, STOVER LOCK, 3/8 - 16
6	4	900-110-161	BUSHING
7	4	190-001-490	BALL BEARING, .875 X 1.875 X .5
8	2	844-069-002	NUT, STOVER LOCK, 7/16 - 14
9	1	806-265-240	SETSCREW, 3/8 - 16 X 1.5
10	2	090-005-564	FRONT LEG
11	2	835-565-002	NUT, HEX JAM, 3/8 - 16
12	2	809-869-365	SCREW, HEX, 3/8 - 16 X 2¼

ITEM	QTY	PART #	DESCRIPTION
------	-----	--------	-------------